

# 1

## 1 CHASSIS 车架部件

PART No.		REF. No.	DESCRIPTION	Q'TY	名称	PRICE USD3
ATV-42-1-1		MDL042-641000	battery plank	1	电池压板	0.73
ATV-42-1-2		MDL042-156100	Pedal brace rear	2	后脚踏支架	3.43
ATV-42-1-3		MDL042-156200	connect plate	2	连接支架	6.43
ATV-42-1-4		MDL042-160000	Pedal brace	2	脚踏支架	7.71
ATV-42-1-5		MDL042-156300	Mulch down	2	下脚踏支架	7.71
ATV-42-1-6		MDL042-865000	band	2	织带	1.71
ATV-42-1-7		915789-101070	Flange Bolt	8	六角法兰螺栓M10x1.25x70	0.56
ATV-42-1-8		MDL042-141110	Fork Axle Sheath	8	内衬管	1.29
ATV-42-1-9		MDL042-141120	Brace covering	16	尼龙衬套	0.21
ATV-42-1-10		MDL042-141100	Upper Rocker Pin	2	前上摆臂组件	10.71
ATV-42-1-11		926187-101000	Flange Nut	12	六角法兰螺母M10x1.25	0.34

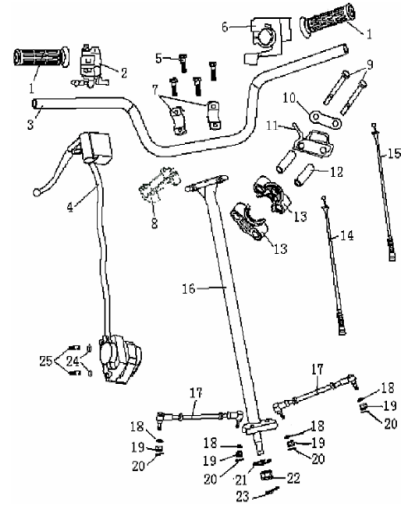













ATV-42-1-12		H:\KMD parts list with price\COPY of ATV 42 MDL042-531000	Steering Knuckle Pin (R)	1	右羊角	9.00
ATV-42-1-13		MDL042-540000	Shock Absorber(may choose)	2	前减震310(可选)	18.00
ATV-42-1-14		915789-101045	Flange Bolt	4	六角法兰螺栓M10x1.25x45	0.56
ATV-42-1-15		909100-250025	Cotter Pin	4	开口销2.5x25	0.34
ATV-42-1-16		929457-142000	Slotted Nut	4	开槽螺母M14x1.5	0.34
ATV-42-1-17		MDL042-141200	Lower Rocker Pin	2	前下摆臂组件	12.00
ATV-42-1-18		915789-080020	Flange Bolt	2	六角法兰螺栓M8x20	0.56
ATV-42-1-19		915789-080016	Flange Bolt	6	六角法兰螺栓M8x16	0.56
ATV-42-1-20		MDL042-170000	BUMPER (may choose)	1	保险杠焊接组件 (可选)	6.00
ATV-42-1-21		MDL042-532000	Steering Knuckle Pin (L)	1	左羊角组件	9.00
ATV-42-1-22		915789-080030	Flange Bolt	6	六角法兰螺栓M8x30	0.56
ATV-42-1-23		MDL042-644000	switch	1	紧急熄火开关	1.80
ATV-42-1-24		MDL042-622000	Rear light	2	尾灯	5.14
ATV-42-1-25		MDL042-600000	Recharge interface	1	充电器接口	1.80
ATV-42-1-26		MDL042-860618	Rubber Washer	9	橡胶垫圈6x18	0.43
ATV-42-1-27		926170-060000	Bolt	6	螺母M6	0.34
ATV-42-1-28		MDL042-120000	Frame Comp.	1	车架焊接组件	123.43



2

2 STEERING PARTS 方向把部件



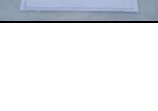

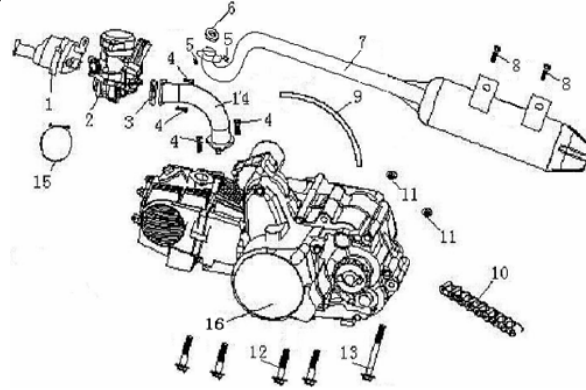





PART NO.		REF. No.	DESCRIPTION	Q'TY	名称	PRICE USD3
ATV-42-2-1		MDL042-572000	Flange Bar Cap.	2	握把	1.29
ATV-42-2-2		MDL042-637000	Function Switch	1	功能开关	4.71
ATV-42-2-3		MDL042-571000	Flandle Bar	1	把手管	8.14
ATV-42-2-4		MDL042-561000	Braking System	1	液压碟刹总成	39.00
ATV-42-2-5		915789-080050	Bolt	4	螺栓M8x50	0.56
ATV-42-2-6		MDL042-231000	Throttle Switch	1	加油器	7.71
ATV-42-2-7		MDL042-571100	HANDLEBAR CLAMP TOP	2	方向把上压块	2.57
ATV-42-2-8		MDL042-571200	HANDLEBAR CLAMP BOTTO	1	方向把下压块	2.14
ATV-42-2-9		915782-080055	Bolt	2	六角螺栓M8X55	0.56





ATV-42-2-10		H:\KMD parts list with price\COPY of ATV 42 MDL042-572400	Stanch flske	1	止退片	0.09
ATV-42-2-11		MDL042-572300	Wire Clamp	1	线卡	0.34
ATV-42-2-12		MDL042-572200	Sleeve Bush	2	方向柱卡子衬套	1.29
ATV-42-2-13		MDL042-572100	Rubber Clamp	2	方向柱卡子座22	1.50
ATV-42-2-14		MDL042-581000	Throttle Cable	1	油门线	2.70
ATV-42-2-15		MDL042-582000	Throttle Cable (may choose	1	风门拉索(可选)	3.00
ATV-42-2-16		MDL042-130000	Steering Shaft Assy	1	方向柱焊接组件	13.29
ATV-42-2-17		MDL042-576000	Steering Tie-rod	2	转向拉杆	7.29
ATV-42-2-18		989300-100000	washer	4	弹垫10	0.34
ATV-42-2-19		929457-101000	Slotted Nut	4	开槽螺母M10x1.25	0.34
ATV-42-2-20		909100-250025	Cotter Pin	4	开口销2.5x25	0.34
ATV-42-2-21		989710-100000	Washer	1	垫圈10	0.34
ATV-42-2-22		926187-101000	Flange Nut	1	六角法兰螺母M10x1.25	0.34
ATV-42-2-23		909100-250025	Cotter Pin	1	开口销2.5x25	0.34
ATV-42-2-24		989300-080000	Washer	2	弹垫8	0.34
ATV-42-2-25		915789-080025	Flange Bolt	2	六角法兰螺栓M8x25	0.43



# 3

## 3 ENGINE 发动机部件

PART NO.		REF. No.	DESCRIPTION	Q'TY	名称	PRICE USD3
ATV-42-3-1		MDL042-321000	Air-cleaner	1	空滤器	2.79
ATV-42-3-2		MDL042-281000	Carburetor	1	化油器	21.00
ATV-42-3-3		MDL042-231000	Bakelite Washer	1	胶木垫	0.86
ATV-42-3-4		915781-060025	Bolt	4	螺栓M6x25	0.43
ATV-42-3-5		926187-060000	Flange Lock Nut	2	六角法兰自锁螺母M6	0.34
ATV-42-3-6		MDL042-312000	exhaust sealing	1	排气管密封圈	0.56
ATV-42-3-7		MDL042-311000	Exhaust Pipe	1	消音器筒体	27.00
ATV-42-3-8		915789-080025	Flange Bolt	2	六角法兰螺栓M8x25	0.56
ATV-42-3-9		MDL042-331300	Fuel Hose	1	进油管	0.86
ATV-42-3-10		420-1-90	Chain	1	420链条 单列 90节	4.29
ATV-42-3-11		926187-080000	Flange Lock Nut	2	六角法兰自锁螺母M8	0.34



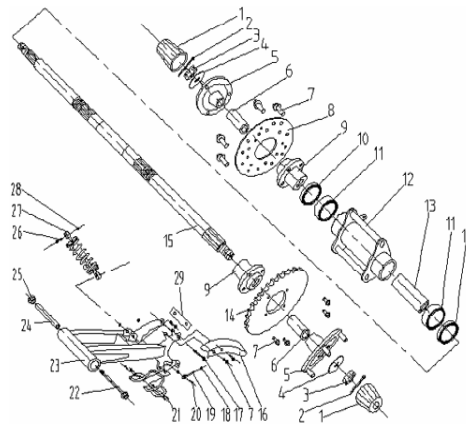













ATV-42-3-12		H:\KMD parts list with price\COPY of ATV 42 915789-080020	Bolt	1	螺栓M8x20	0.43
ATV-42-3-13		915789-080105	Bolt	1	螺栓M8x105	0.86
ATV-42-3-14		MDL042-232000	Joint Carburetor	1	进气管DC34-2	5.14
ATV-42-3-15		MDL042-322000	Air-cleaner Clamp	1	空滤器抱箍	0.34
ATV-42-3-16		MDL042-200000	Engine	1	发动机	352.29









# 4

## 4 AXLE 后轴部件

PART NO.		REF. No.	DESCRIPTION	Q'TY	名称	PRICE USD3
ATV-42-4-1		MDL042-525000	Dust Cover	2	防尘盖	0.43
ATV-42-4-2		909100-300030	Cotter Pin	2	开口销3x30	0.43
ATV-42-4-3		929457-162000	Slotted Nut	2	开槽螺母M16x1.5	0.56
ATV-42-4-4		989710-164804	washer	2	垫圈17x48x4	0.86
ATV-42-4-5		MDL042-523000	Rear Rim Seat	2	后轮毂座	5.14
ATV-42-4-6		MDL042-526000	Bush	2	后轴套管	2.57



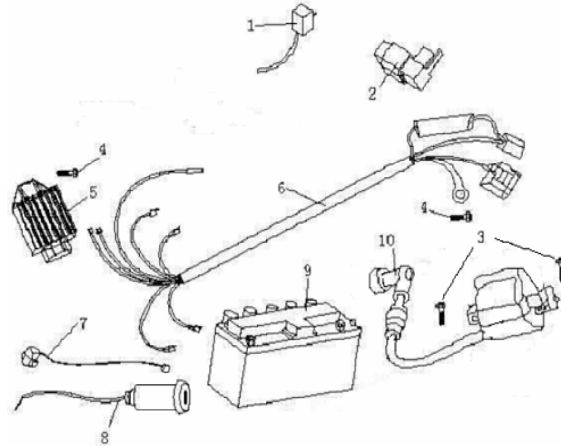

ATV-42-4-7		H:\KMD parts list with price\COPY of ATV 42 915789-080016	Flange Bolt	8	六角法兰螺栓M8x16	0.56
ATV-42-4-8		MDL042-562100	Disc Brake	1	刹车盘	9.00
ATV-42-4-9		MDL042-562200	Disc Brake Seat	1	刹车\链轮盘座	3.00
ATV-42-4-10		13871-423007	Oil Seal	2	油封42x30x7	0.43
ATV-42-4-11		942760-61905RS	Bearing Ball DBL Seal	2	轴承61905-2RS	2.14
ATV-42-4-12		MDL042-462100	Rear Axle Block	1	后桥座	10.71
ATV-42-4-13		MDL042-462200	Rear Axle Bush	1	后桥座内衬管	1.71
ATV-42-4-14		MDL042-471000	Drive Sprocket	1	链轮盘	5.14
ATV-42-4-15		MDL042-461000	Rear Axle	1	后轴	15.00
ATV-42-4-16		MDL042-194100	Drive Sprocket Shield (High)	1	链罩	5.14
ATV-42-4-17		915789-101115	Flange Bolt	2	六角法兰螺栓M10x1.25x115	1.71
ATV-42-4-18		928891-080000	Lock Nut	2	非金属嵌件六角锁紧螺母M8	0.34
ATV-42-4-19		MDL042-195090	Adjust Bolt	2	千斤	1.71
ATV-42-4-20		915789-101025	Flange Bolt	2	六角法兰螺栓M10x1.25x25	0.56
ATV-42-4-21		MDL042-193000	Drive Sprocket Shield (Low)	1	后桥保护架	0.51
ATV-42-4-22		915789-142235	Rear Axle	1	后叉安装螺栓M14x1.5x235	3.00
ATV-42-4-23		MDL042-191000	Rear Fork	1	后叉焊接组件	25.71





ATV-42-4-24		H:\KMD parts list with price\COPY of ATV 42 MDL042-192000	Bush	1	后叉内衬管	3.00
ATV-42-4-25		926187-142000	Flange Lock Nut	1	六角法兰自锁螺母M14x1.5	0.34
ATV-42-4-26		915789-101045	Flange Bolt	2	六角法兰螺栓M10x1.25x45	0.56
ATV-42-4-27		MDL042-550000	Shock Absorber (may cho	1	后减震280 (可选)	10.71
ATV-42-4-28		926187-101000	Flange Lock Nut	2	六角法兰自锁螺母M10x1.25	0.34
ATV-42-4-29		MDL042-196000	Rear plate	1	后摆臂加强板	1.50



## 5

### 5 ELECTRIC HARDWARES 电器件

REF. No.		PART NO.	DESCRIPTION	Q'TY	名称	PRICE USD3
ATV-42-5-1		MDL042-639000	Charger (may choose)	1	充电器 (选装)	8.57
ATV-42-5-2		MDL042-634000	CDI	1	CDI	3.86
ATV-42-5-3		915789-060020	Bolt	2	螺栓M6x20	0.43
ATV-42-5-4		915789-060016	Bolt	2	螺栓M6x16	0.43
ATV-42-5-5		MDL042-636000	Regulator	1	稳压器	5.14

ATV-42-5-6		H:\KMD parts list with price\COPY of ATV 42 MDL042-632000	Main Wire	1	主电缆	11.57
ATV-42-5-7		MDL042-635000	Relay	1	继电器	3.64
ATV-42-5-8		MDL042-637000	Electrical Switch	1	电门锁	3.43
ATV-42-5-9		MDL042-631100	Battery	1	电池12V、5AH (GT5-3)	32.57
ATV-42-5-10		MDL042-633000	Coil	1	高压包	4.29

5

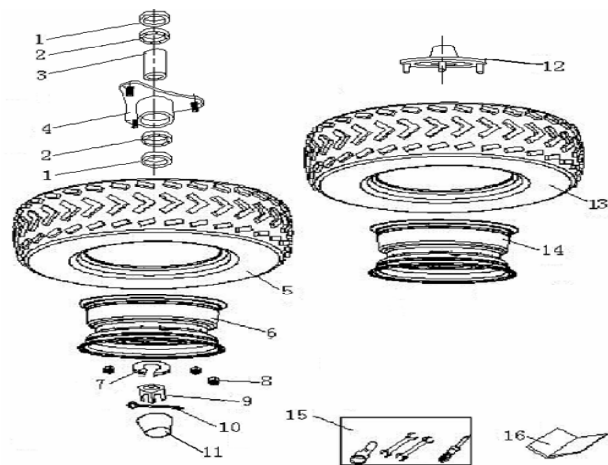

# 6

## 6 TYRE 轮系

REF. No.		PART No.	DESCRIPTION	Q'TY	名称	PRICE USD3
ATV-42-6-1		993871-322005	Oil Seal	2	油封32x20x5	0.34
ATV-42-6-2		942760-6002Z	Bearing Ball DBL Seal	4	轴承6002-2RS	1.71
ATV-42-6-3		MDL042-513200	Sleeve Bush	2	隔套管	2.14
ATV-42-6-4		MDL042-513100	Front Rim Seat	2	前轮毂座	3.86





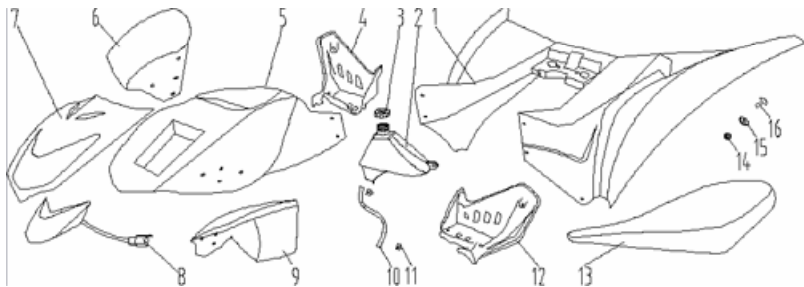









ATV-42-6-5		H:\KMD parts list with price\COPY of ATV 42 MDL042-511100	Front Tyre (grain may choose)	2	前轮胎16x8-7 (花纹可选)	34.71
ATV-42-6-6		MDL042-511200	Front Rim	2	前轮毂7寸	9.86
ATV-42-6-7		989300-200000	washer	2	弹垫14	0.34
ATV-42-6-8		926187-080000	Flange Lock Nut	12	六角法兰自锁螺母M8	0.34
ATV-42-6-9		929457-142000	Slotted Nut	4	开槽螺母M14x1.5/M16x1.5	0.56
ATV-42-6-10		909100-030030	Cotter Pin	4	开口销2.5x25/3x30	0.34
ATV-42-6-11		MDL042-525000	Dust Cover	4	防尘盖	0.34
ATV-42-6-12		MDL042-523000	Rear Rim Seat	2	后轮毂座	10.71
ATV-42-6-13		MDL042-521100	Rear Tyre (grain may choose)	2	后轮胎16x8-7 (花纹可选)	34.71
ATV-42-6-14		MDL042-521200	Rear Rim	2	后轮毂7寸	9.86
ATV-42-6-15		MDL042-830000	Tool Kit	1	随车工具	3.86
ATV-42-6-16		MDL042-840000	Owners Manual	1	说明书	1.29

6



7

## 7 FENDER 覆盖件

REF. No.		PART No.	DESCRIPTION	Q'TY	名称	PRICE USD3
ATV-42-7-1		MDL042-721300	Rear Fender	1	后外衣	18.00
ATV-42-7-2		MDL042-331000	Gas Tank	1	油箱组件	4.71
ATV-42-7-3		MDL042-331200	Gas Tank Cap	1	油箱盖	
ATV-42-7-4		MDL042-721500	Foot Pedal ®	1	右脚踏板	4.29
ATV-42-7-5		MDL042-721200	Front Fender	1	前外衣	8.00
ATV-42-7-6		MDL042-721800	dust brace®	1	右挡泥板	4.29
ATV-42-7-7		MDL042-721400	Upside Panel	1	塑料件头盖	5.14
ATV-42-7-8		MDL042-621000	Front Head Light	1	前大灯组件	9.00
ATV-42-7-9		MDL042-721700	dust brace (L)	1	左挡泥板	4.29
ATV-42-7-10		MDL042-331100	Fuel Hose	2	油管	0.56
ATV-42-7-11		MDL042-760085	Hose Clamp	4	油管卡扣	0.21
ATV-42-7-12		MDL042-721600	Foot Pedal (L)	1	左脚踏板	4.29
ATV-42-7-13		MDL042-710000	Seat	1	坐垫组件	15.00
ATV-42-7-14		908180-060020	Screw	30	大盘头螺钉M6x20	0.56
ATV-42-7-15		MDL042-860618	Rubber Washer	20	橡胶垫圈6x18	0.34

ATV-42-7-16		H:\KMD parts list with price\COPY of ATV 42	926177-060000	Nut	26	螺母M6(防滑)	0.34
-------------	---	---	---------------	-----	----	----------	------





























