

## ATV-25 R

110CC

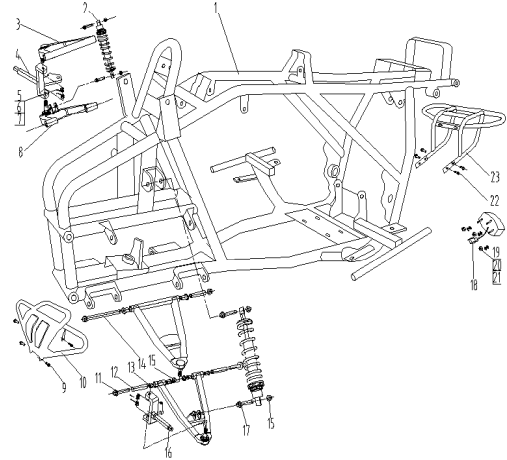











### ATV DIAGRAM MANUAL PARTS CATALOG



1

## 1 CHASSIS 车架部件

PARTS NO	RE NO	IMAGE	DESCRIPTION	Q'TY	名称	PRICE USD3	
ATV-25R-1	MDL025-120000		Frame Comp.	1	车架焊接组件	123.43	
ATV-25R-2	MDL025-540000		Front Shock Absorber(may choose)	2	前减震280(可选)	30.00	
ATV-25R-3	MDL025-141100		Upper Rocker Pin	2	前上摆臂组件	10.71	
ATV-25R-4	MDL025-531000		Steering Knuckle Pin (R)	1	右羊角	9.00	
ATV-25R-5	989300-140000		Washer	4	弹垫14	0.34	
ATV-25R-6	909100-250025		Cotter Pin	4	开口销2.5x25	0.34	
ATV-25R-7	929457-142000		Slotted Nut	4	开槽螺母M14x1.5	0.34	
ATV-25R-8	MDL025-141200		Lower Rocker Pin	2	前下摆臂组件	12.00	

ATV-25R-9	915789-080016		H:\KMD parts list with price\ATV 25 Flange Bolt	4	六角法兰螺栓M8x16	0.56	
ATV-25R-10	MDL025-170000		BUMPER (may choose)	1	保险杠焊接组件 (可选)	6.00	
ATV-25R-11	915789-101070		Flange Bolt	4	角法兰螺栓M10x1.25x	0.86	
ATV-25R-12	MDL025-141110		Fork Axle Sheath	4	内衬管	1.29	
ATV-25R-13	MDL025-141120		Brace covering	12	尼龙衬套	0.21	
ATV-25R-14	915789-101180		Flange Bolt	2	角法兰螺栓M10x1.25x1	0.86	
ATV-25R-15	926187-101000		Flange Nut	10	六角法兰螺母M10x1.25	0.34	
ATV-25R-16	MDL025-532000		Steering Knuckle Pin (L)	1	左羊角组件	9.00	
ATV-25R-17	915789-101045		Flange Bolt	4	角法兰螺栓M10x1.25x	0.56	
ATV-25R-18	MDL025-622000		Rear light	2	尾灯	5.14	
ATV-25R-19	989710-060000		Washer	6	平垫6	0.43	
ATV-25R-20	989300-060000		Washer	6	弹垫6	0.43	
ATV-25R-21	926170-060000		Bolt	6	螺母M6	0.34	
ATV-25R-22	915789-080012		Flange Bolt	6	六角法兰螺栓M8x12	0.51	
ATV-25R-23	MDL025-181000		Rear shelf	1	后保护架		

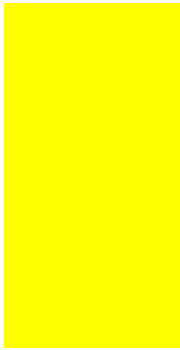

## ATV DIAGRAM MANUAL PARTS CATALOG

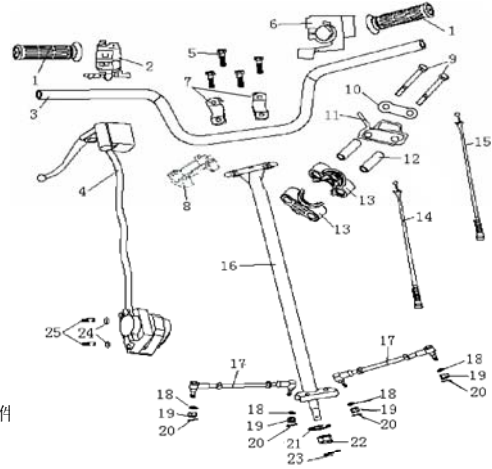



2 STEERING PARTS 方向把部件

2

REF. No.	PART NO.		DESCRIPTION	Q'TY	名称	PRICE USD3	
ATV-25R-2-1	MDL025-572000		Flangle Bar Cap.	2	握把	1.29	
ATV-25R-2-2	MDL025-637000		Function Switch	1	功能开关	15.86	
ATV-25R-2-3	MDL025-571000		Flandle Bar	1	把手管	8.14	
ATV-25R-2-4	MDL025-561000		Braking System	1	液压碟刹总成	39.00	
ATV-25R-2-5	915789-080050		Bolt	4	螺栓M8x50	0.56	
ATV-25R-2-6	MDL025-231000		Throttle Switch	1	加油器	7.71	
ATV-25R-2-7	MDL025-571100		HANDLEBAR CLAMP TOP	2	方向把上压块	2.57	

			H:\KMD parts list with price\ATV 25				
ATV-25R-2-8	MDL025-571200		HANDLEBAR CLAMP BOTTOM	1	方向把下压块	2.14	
ATV-25R-2-9	915782-080055		Bolt	2	六角螺栓M8X55	0.56	
ATV-25R-2-10	MDL025-572400		Stanch flske	1	止退片	0.09	
ATV-25R-2-11	MDL025-572300		Wire Clamp	1	线卡	0.34	
ATV-25R-2-12	MDL025-572200		Sleeve Bush	2	方向柱卡子衬套	1.29	
ATV-25R-2-13	MDL025-572100		Rubber Clamp	2	方向柱卡子座22	1.50	
ATV-25R-2-14	MDL025-581000		Throttle Cable	1	油门线	3.00	
ATV-25R-2-15	MDL025-582000		Choke Cable (may choose)	1	风门拉索(可选)	3.00	
ATV-25R-2-16	MDL025-130000		Steering Shaft Assy	1	方向柱焊接组件	13.29	
ATV-25R-2-17	MDL025-576000		Steering Tie-rod	2	转向拉杆	7.29	
ATV-25R-2-18	989300-100000		washer	4	弹垫10	0.43	
ATV-25R-2-19	929457-101000		Slotted Nut	4	开槽螺母M10x1.25	0.34	
ATV-25R-2-20	909100-250025		Cotter Pin	4	开口销2.5x25	0.34	
ATV-25R-2-21	989710-100000		Washer	1	垫圈10	0.34	
ATV-25R-2-22	926187-101000		Flange Nut	1	六角法兰螺母M10x1.25	0.34	
ATV-25R-2-23	909100-250025		Cotter Pin	1	开口销2.5x25	0.34	

ATV-25R-2-24	989300-080000		H:\KMD parts list with price\ATV 25 Washer	2	弹垫8	0.34	
ATV-25R-2-25	915789-080025		Flange Bolt	2	六角法兰螺栓M8x25	0.43	

### ATV DIAGRAM MANUAL PARTS CATALOG

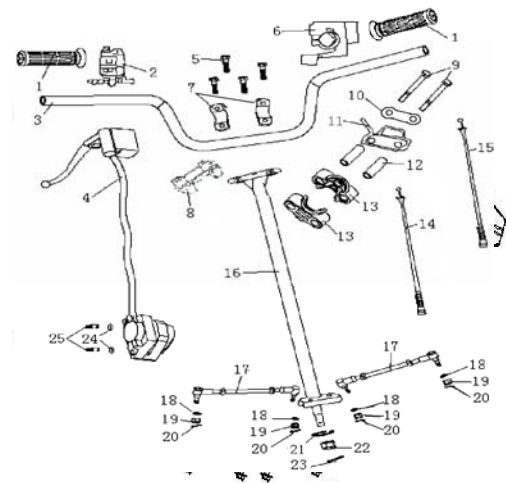

3 ENGINE 发动机部件

3							
REF. No.	PART No.		DESCRIPTION	Q'TY	名称	PRICE USD3	
ATV-25R-3-1	MDL025-321000		Air-cleaner	1	空滤器	2.70	
ATV-25R-3-2	MDL025-281000		Carburetor	1	化油器	20.57	
ATV-25R-3-3	MDL025-231000		Bakelite Washer	1	胶木垫	0.86	

H:\KMD parts list with price\ATV 25							
ATV-25R-3-4	915781-060025		Bolt	4	螺栓M6x25	0.43	
ATV-25R-3-5	926187-060000		Flange Lock Nut	2	六角法兰自锁螺母M6	0.34	
ATV-25R-3-6	MDL025-312000		exhaust sealing	1	排气管密封圈	0.56	
ATV-25R-3-7	MDL025-311000		Exhaust Pipe	1	消音器筒体	27.00	
ATV-25R-3-8	915789-080025		Flange Bolt	2	六角法兰螺栓M8x25	0.56	
ATV-25R-3-9	MDL025-331300		Fuel Hose	1	进油管	0.86	
ATV-25R-3-10	420-1-88		Chain	1	420链条 单列 88节	4.29	
ATV-25R-3-11	926187-080000		Flange Lock Nut	2	六角法兰自锁螺母M8	0.34	
ATV-25R-3-12	915789-080020		Bolt	1	螺栓M8x20	0.43	
ATV-25R-3-13	915789-080105		Bolt	1	螺栓M8x105	0.86	
ATV-25R-3-14	MDL025-232000		Joint Carburetor	1	进气管DC34-2	5.14	
ATV-25R-3-15	MDL025-322000		Air-cleaner Clamp	1	空滤器抱箍	0.34	
ATV-25R-3-16	MDL025-200000		Engine	1	发动机	182.06	

## ATV DIAGRAM MANUAL PARTS CATALOG

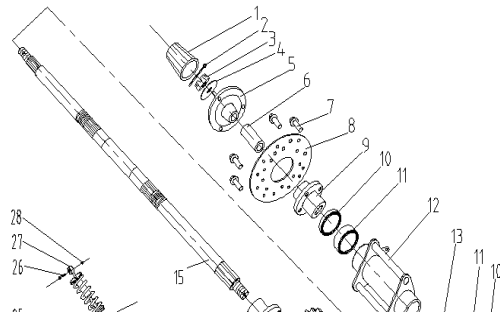



H:\KMD parts list with price\ATV 12

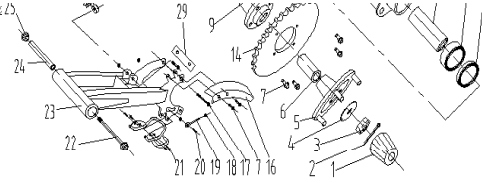

4 AXLE 后轴部件

4							
REF. No.	PART NO.		DESCRIPTION	Q'TY	名称	PRICE USD3	
ATV-25R-4-1	MDL025-525000		Dust Cover	2	防尘盖	0.43	
ATV-25R-4-2	909100-300030		Cotter Pin	2	开口销3x30	0.43	
ATV-25R-4-3	929457-162000		Slotted Nut	2	开槽螺母M16x1.5	0.56	
ATV-25R-4-4	989710-164804		washer	2	垫圈17x48x4	0.86	
ATV-25R-4-5	MDL025-523000		Rear Rim Seat	2	后轮毂座	5.14	
ATV-25R-4-6	MDL025-526000		Bush	2	后轴套管	2.14	
ATV-25R-4-7	915789-080016		Flange Bolt	8	六角法兰螺栓M8x16	0.56	
ATV-25R-4-8	MDL025-562100		Disc Brake	1	刹车盘	9.00	
ATV-25R-4-9	MDL025-562200		Disc Brake Seat	2	刹车链轮盘座	3.00	
ATV-25R-4-10	13871-423007		Oil Seal	2	油封42x30x7	0.43	
ATV-25R-4-11	942760-61905RS		Bearing Ball DBL Seal	2	轴承61905-2RS	2.14	
ATV-25R-4-12	MDL025-462100		Rear Axle Block	1	后桥座	10.71	
ATV-25R-4-13	MDL025-462200		Rear Axle Bush	1	后桥座内衬管	1.71	

Part No.	Part Name	Image	Description	Quantity	Unit Price	Total Price
ATV-25R-4-14	MDL025-471000		Drive Sprocket	1	5.57	5.57
ATV-25R-4-15	MDL025-461000		Rear Axle	1	33.43	33.43
ATV-25R-4-16	MDL025-194100		Drive Sprocket Shield (Higher)	1	5.14	5.14
ATV-25R-4-17	915789-101115		Flange Bolt	2	1.71	1.71
ATV-25R-4-18	928891-080000		Lock Nut	2	0.34	0.34
ATV-25R-4-19	MDL025-195090		Adjust Bolt	2	1.71	1.71
ATV-25R-4-20	915789-101025		Flange Bolt	2	0.56	0.56
ATV-25R-4-21	MDL025-193000		Drive Sprocket Shield (Lower)	1	0.51	0.51
ATV-25R-4-22	915789-142235		Rear Axle	1	3.00	3.00
ATV-25R-4-23	MDL025-191000		Rear Fork	1	25.71	25.71
ATV-25R-4-24	MDL025-192000		Bush	1	3.00	3.00
ATV-25R-4-25	926187-142000		Flange Lock Nut	1	0.34	0.34
ATV-25R-4-26	915789-101045		Flange Bolt	2	0.56	0.56
ATV-25R-4-27	MDL025-550000		Rear Shock Absorber (may choose)	1	30.00	30.00
ATV-25R-4-28	926187-101000		Flange Lock Nut	2	0.34	0.34
ATV-25R-4-29	MDL025-196000		Rear plate	1	1.50	1.50

## ATV DIAGRAM MANUAL

# PARTS CATALOG

H:\KMD parts list with price\ATV 25

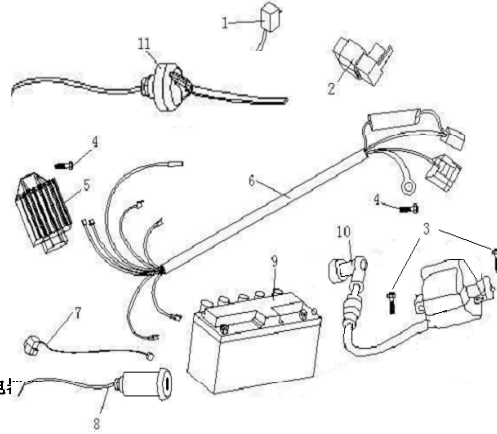

5 ELECTRIC HARDBESS 电

5		REF. No.	PART NO.	DESCRIPTION	Q'TY	名称	PRICE USD3
ATV-25R-5-1	MDL025-639000		Charger (may choose)	1	充电器 (选装)	8.57	
ATV-25R-5-2	MDL025-634000		CDI	1	CDI	3.86	
ATV-25R-5-3	915789-060020		Bolt	2	螺栓M6x20	0.43	
ATV-25R-5-4	915789-060016		Bolt	2	螺栓M6x16	0.43	
ATV-25R-5-5	MDL025-636000		Regulator	1	稳压器	5.14	
ATV-25R-5-6	MDL025-632000		Main Wire	1	主电缆	8.57	
ATV-25R-5-7	MDL025-635000		Relay	1	继电器	3.64	
ATV-25R-5-8	MDL025-637000		Electrical Switch	1	电门锁	3.43	
ATV-25R-5-9	MDL025-631000		Battery	1	电池12V、5AH (GT5-3)	15.00	
ATV-25R-5-10	MDL025-633000		Coil	1	高压包	4.29	
ATV-25R-5-11	MDL025-638000		Emergence Switch (may choose)	1	紧急熄火开关 (选装)		

# ATV DIAGRAM MANUAL PARTS CATALOG

H:\KMD parts list with price\ATV 25

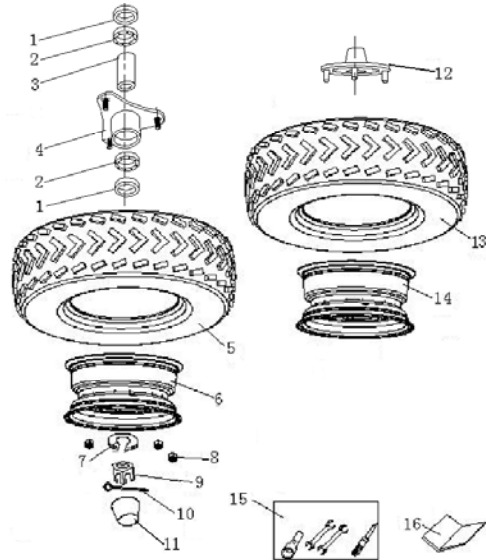

6 TYRE 轮系



6							
REF. No.	PART No.		DESCRIPTION	QTY	名称	PRICE USD3	
ATV-25R-6-1	13871-322005		Oil Seal	2	油封32x20x5	0.34	
ATV-25R-6-2	942760-6002		Bearing Ball DBL Seal	4	轴承6002-2RS	1.71	
ATV-25R-6-3	MDL025-513200		Sleeve Bush	2	隔套管	2.14	
ATV-25R-6-4	MDL025-513100		Front Rim Seat	2	前轮毂座	3.86	
ATV-25R-6-5	MDL025-511100		Front Tyre (grain may choose)		前轮胎16x8-7 (花纹可选)	36.43	
ATV-25R-6-6	MDL025-511200		Front Rim	2	前轮毂7寸	9.00	
ATV-25R-6-7	989300-200000		washer	2	弹垫14	0.34	
ATV-25R-6-8	926187-080000		Flange Lock Nut	12	六角法兰自锁螺母M8	0.34	
ATV-25R-6-9	929457-142000		Slotted Nut	4	开槽螺母M14x1.5/M16x1.5	0.56	
ATV-25R-6-10	909100-030030		Cotter Pin	4	开口销2.5x25/3x30	0.34	

ATV-25R-6-11	MDL025-525000		H:\KMD parts list with price\ATV 25 Dust Cover	4	防尘盖	0.34	
ATV-25R-6-12	MDL025-523000		Rear Rim Seat	2	后轮毂座	10.71	
ATV-25R-6-13	MDL025-521100		Rear Tyre (grain may choose)	2	后轮胎16x8-7 (花纹可选)	36.43	
ATV-25R-6-14	MDL025-521200		Rear Rim	2	后轮辋7寸	9.00	
ATV-25R-6-15	MDL025-830000		Tool Kit	1	随车工具	3.86	
ATV-25R-6-16	MDL025-840000		Owners Manual	1	说明书	1.71	

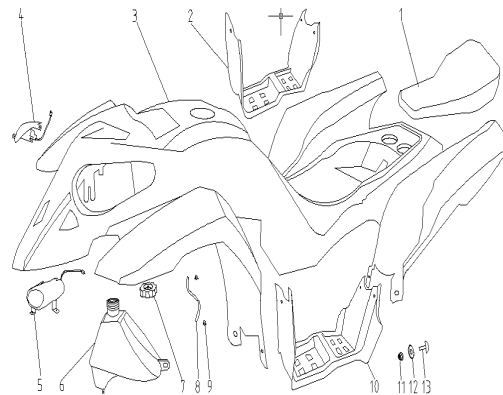
### ATV DIAGRAM MANUAL PARTS CATALOG



7 FENDER 覆盖件

7							
REF. No.	PART No.		DESCRIPTION	Q'TY	名称	PRICE USD3	
ATV-25R-7-1	MDL025-710000		Seat	1	坐垫组件	12.00	
ATV-25R-7-2	MDL025-721300		Foot Pedal®	1	右脚踏板	4.29	
ATV-25R-7-3	MDL025-721100		Front Fender	1	前外衣	36.00	
ATV-25R-7-4	MDL025-621100		Front Head Light®	1	右前大灯组件	5.14	

H:\KMD parts list with price\ATV 25							
ATV-25R-7-5	MDL025-621200		Front Head Light(L)	1	左前大灯组件	5.14	
ATV-25R-7-6	MDL025-331000		Gas Tank	1	油箱组件	4.71	
ATV-25R-7-7	MDL025-331200		Gas Tank Cap	1	油箱盖		
ATV-25R-7-8	MDL025-760085		Hose Clamp	4	油管卡扣	0.21	
ATV-25R-7-9	MDL025-331100		Fuel Hose	2	油管	0.21	
ATV-25R-7-10	MDL025-721200		Foot Pedal (L)	1	左脚踏板	4.29	
ATV-25R-7-11	908180-060020		Screw	12	大盘头螺钉M6x20	0.56	
ATV-25R-7-12	MDL025-860618		Rubber Washer	18	橡胶垫圈6x18	0.34	
ATV-25R-7-13	926177-060000		Nut	12	螺母M6(防滑)	0.34	